

Data sheet | Item number: 280-504/281-584

Component terminal block; double-deck; with end plate; with varistor; for DIN-rail 35 x 15 and 35 x 7.5; 2.5 mm²; CAGE CLAMP®; 2,50 mm²; gray

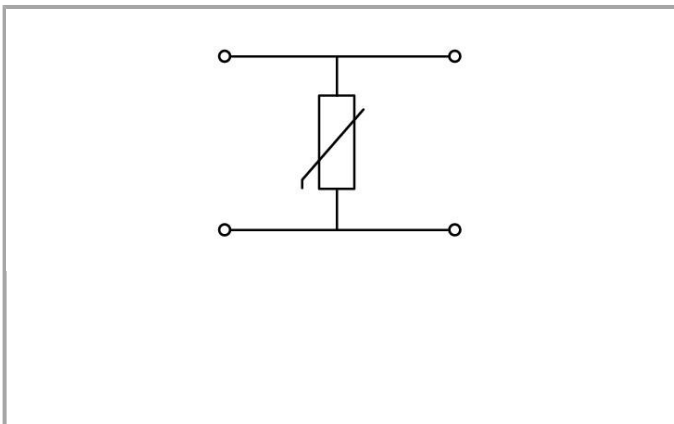

280-504_281-584

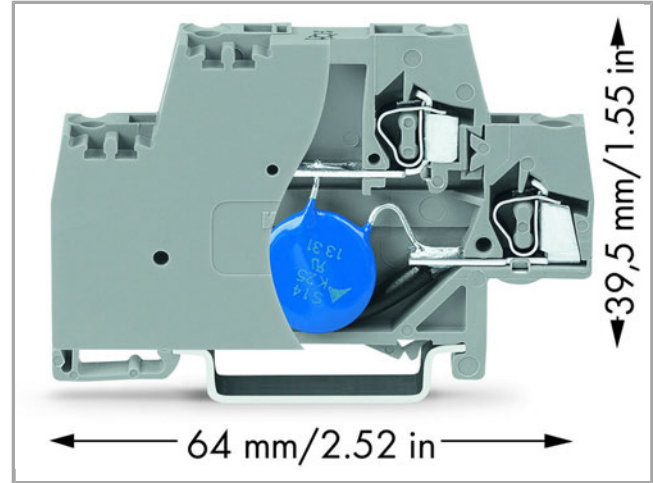
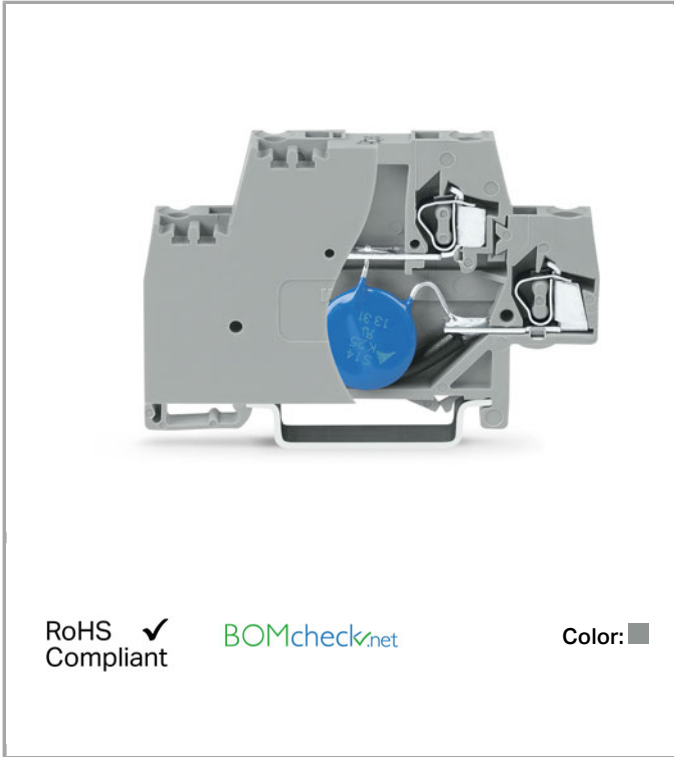

Item description

Short description:

Terminal blocks with surge suppression device and direct connection to the DIN-35 rail; these single-stage surge suppression devices are equipped either with 280 Series gas-filled surge arrester (coarse), varistor (medium) or suppressor diode (fine).

Features:

—



- Protect your system against overvoltage
- Slim, space-saving design
- Control operational costs by preventing expensive, unplanned downtime
- High operational reliability and system uptime

Data

Electrical data

Nominal operating voltage	DC 60 V
Maximum continuous operating voltage	DC 85 V
Rated continuous current	20 A
Nominal discharge current (8/20 μ s) per line	1 kA
Max. discharge current	4.5 kA
Voltage protection level (8/20 μ s)	\leq DC 165 V
Capacitance	\leq 1.7 nF

Connection data

Connections (number)	4
Connection technology	CAGE CLAMP®
Solid conductor	0.08 2.5 mm ² / 28 14 AWG
Fine-stranded conductor	0.08 2.5 mm ² / 28 14 AWG
Strip length	8 9 mm / 0.31 0.35 inch

Geometrical Data

Width	10 mm / 0.394 inch
Height from upper-edge of DIN-35 rail	39.5 mm / 1.555 inch
Depth	64 mm / 2.52 inch

Mechanical data

Design	With end plate
Type of mounting	DIN-35 rail

Material Data

Color	gray
Fire load	0.265 MJ
Weight	15.189 g













Commercial data















Product Group	1 (Rail Mounted Terminal Blocks)
Country of origin	DE

GTIN	4050821514930
Customs Tariff No.	85369010000

Compatible products

Marking accessories

	Item no.: 2009-145 Mini-WSB Inline; for Smart Printer; on reel; stretchable 5 - 5.2 mm; plain; snap-on type; white	2009-145
	Item no.: 2009-145/000-002 Mini-WSB Inline; for Smart Printer; on reel; stretchable 5 - 5.2 mm; plain; snap-on type; yellow	2009-145 /000-002
	Item no.: 2009-145/000-005 Mini-WSB Inline; for Smart Printer; on reel; stretchable 5 - 5.2 mm; plain; snap-on type; red	2009-145 /000-005
	Item no.: 2009-145/000-006 Mini-WSB Inline; for Smart Printer; on reel; stretchable 5 - 5.2 mm; plain; snap-on type; blue	2009-145 /000-006
	Item no.: 2009-145/000-007 Mini-WSB Inline; for Smart Printer; on reel; stretchable 5 - 5.2 mm; plain; snap-on type; gray	2009-145 /000-007
	Item no.: 2009-145/000-012 Mini-WSB Inline; for Smart Printer; on reel; stretchable 5 - 5.2 mm; plain; snap-on type; orange	2009-145 /000-012
	Item no.: 2009-145/000-023 Mini-WSB Inline; for Smart Printer; on reel; stretchable 5 - 5.2 mm; plain; snap-on type; green	2009-145 /000-023
	Item no.: 2009-145/000-024 Mini-WSB Inline; for Smart Printer; on reel; stretchable 5 - 5.2 mm; plain; snap-on type; violet	2009-145 /000-024
	Item no.: 248-501 Miniature WSB Quick marking system; plain; Marker width 5 mm; 10 strips with 10 markers per card	248-501
	Item no.: 248-501/000-002 Mini-WSB marking card; as card; not stretchable; plain; snap-on type; yellow	248-501 /000-002
	Item no.: 248-501/000-005 Mini-WSB marking card; as card; not stretchable; plain; snap-on type; white	248-501 /000-005
	Item no.: 248-501/000-006 Mini-WSB marking card; as card; not stretchable; plain; snap-on type; white	248-501 /000-006

	Item no.: 248-501/000-007 Mini-WSB marking card; as card; not stretchable; plain; snap-on type; white	248-501 /000-007
	Item no.: 248-501/000-012 Mini-WSB marking card; as card; not stretchable; plain; snap-on type; white	248-501 /000-012
	Item no.: 248-501/000-017 Mini-WSB marking card; as card; not stretchable; plain; snap-on type; white	248-501 /000-017
	Item no.: 248-501/000-023 Mini-WSB marking card; as card; not stretchable; plain; snap-on type; white	248-501 /000-023
	Item no.: 248-501/000-024 Mini-WSB marking card; as card; not stretchable; plain; snap-on type; white	248-501 /000-024
Insulation stop		
	Item no.: 280-470 Insulation stop; 0.08 - 0.2 mm ² "s" (0.14 mm ² "f-st"); 5 pieces/strip; white	280-470
	Item no.: 280-471 Insulation stop; 0.25 - 0.5 mm ² ; 5 pieces/strip; light gray	280-471
	Item no.: 280-472 Insulation stop; 0.75 - 1 mm ² ; 5 pieces/strip	280-472
Jumper		
	Item no.: 280-482 Comb-style jumper bar; insulated; 2-way; IN = IN terminal block; gray	280-482
	Item no.: 280-483 Comb-style jumper bar; insulated; 3-way; IN = IN terminal block; gray	280-483
	Item no.: 280-484 Comb-style jumper bar; insulated; 4-way; IN = IN terminal block; gray	280-484
	Item no.: 280-485 Comb-style jumper bar; insulated; 5-way; IN = IN terminal block; gray	280-485
	Item no.: 280-490 Comb-style jumper bar; insulated; 10-way; IN = IN terminal block; gray	280-490
	Item no.: 280-492 Alternate comb-style jumper bar; insulated; 2-way; IN = IN terminal block; gray	280-492
tools		
	Item no.: 210-720 Operating tool; Blade: 3.5 x 0.5 mm; with a partially insulated shaft	210-720

Downloads

Documentation

Additional Information



Disposal; Electrical and electronic equipment, Packaging

V 1.0.0

pdf
265.8 kB

[Download](#)

CAD/CAE - Smart Data

CAD data

3D Download 280-504/281-584

[URL](#)

[Download](#)

EPLAN

EPLAN Data Portal

[Download](#)

WSCAD

WSCAD Universe

[Download](#)

Subject to changes.
